

Nikon

www.butkus.us
Nikon

No reproduction in any form of this manual, in whole or in part (except for brief quotation in critical articles or reviews), may be made without written authorization from NIKON CORPORATION.

Queda prohibida la reproducción total o parcial de este folleto (salvo en lo que se refiere a citas breves en artículos o revistas especializadas), sin la autorización escrita de NIKON CORPORATION.

NIKON CORPORATION

FUJI BLDG., 2-3, MARUNOUCHI 3-CHOME
CHIYODAKU, TOKYO 100-8331, JAPAN

Printed in China Y9101 (23)

Instruction Manual (Pages 2-49)
Manual de instrucciones (Páginas 50-97)

Lite•Touch
Zoom 120 ED

Lite•Touch
Zoom 120 ED QD

E

S



This manual is for reference and historical purposes, all rights reserved.

This page is copyright© by M. Butkus, NJ.

This page may not be sold or distributed without the expressed permission of the producer

I have no connection with any camera company

On-line camera manual library

This is the full text and images from the manual. This may take 3 full minutes for the PDF file to download.

If you find this manual useful, how about a donation of \$3 to: M. Butkus, 29 Lake Ave., High Bridge, NJ 08829-1701 and send your e-mail address so I can thank you. Most other places would charge you \$7.50 for a electronic copy or \$18.00 for a hard to read Xerox copy.

This will allow me to continue to buy new manuals and pay their shipping costs.

It'll make you feel better, won't it?

**If you use Pay Pal or wish to use your credit card,
click on the secure site on my main page.**

Thank you for purchasing the Nikon Lite Touch Zoom 120ED / Lite Touch Zoom 120ED QD camera.

Be sure to read this manual thoroughly before use, and keep it handy until you feel confident using the camera.

Your Nikon camera features:

- Compact, light-weight construction with built-in 3.2X zoom lens from 38 to 120 mm focal length range. (👉 p. 21)
- A Nikon ED (Extra-low Dispersion) lens with low chromatic aberration (popularly used as lenses for Nikon single-lens reflex cameras), as well as two high-contrast, high-resolution aspherical lenses.
- The camera automatically fires the flash when the subject is backlit. (👉 p. 32)
- A viewfinder eyepiece that will not easily become fogged up even if you breathe on it. (👉 p. 17)

Symbols used in this manual

- ☑ : Indicates items to be checked, such as requirements and restrictions.
- 👉 : Indicates notes and cautions you are requested to follow.
- ⦿ : Indicates supplementary descriptions.
- 👉 : Indicates pages for reference.

Accessories

(The following item is supplied with this camera.)

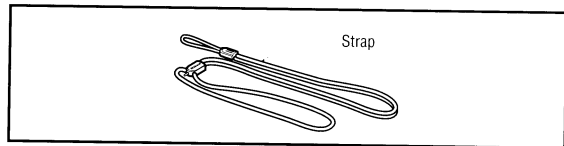

Optional accessories

- Camera case CS-L23
(Remote control unit can be stored in the pocket inside.)
- Remote control unit ML-L1 (👉 p. 39)
- Remote control unit case CML-L1

Attaching the strap

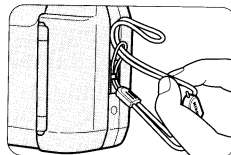

Attach the strap as shown in the illustration.

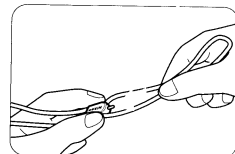

Adjust the length using the lug on the strap.

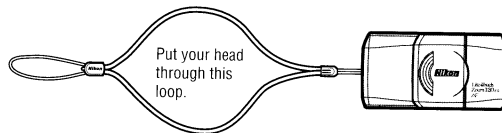

Table of Contents

To take a picture right away _____	6
Camera parts _____	8-10
Body _____	8-9
LCD panel _____	10
Indications in the viewfinder _____	11

Preparations

Installing a battery _____	12
Turning the camera on _____	13
Checking the battery power _____	13
Loading the film _____	14

Basic Operations

Imprinting the date/time on pictures (Lite Touch Zoom 120ED QD only) _____	16
Adjusting diopter _____	17
Holding the camera properly _____	18
Operating the Shutter Release button _____	19
Selecting Panorama mode (Lite Touch Zoom 120ED QD only) _____	20
Zooming _____	21
Shooting _____	22
Rewinding the film _____	24
Removing the film _____	25

3 Advanced Operations

When the main subject is not in the center of the picture _____	26
Difficult-to-focus subjects _____	28
Close-up photography _____	29
Flash photography _____	30
To automatically fire the flash _____	32
To cancel flash operation _____	33
To fire the flash intentionally _____	34
To photograph a person in a night view _____	35
To reduce the "Red-eye" effect _____	36
Using the self-timer _____	38
Using the remote control (optional) _____	39
Shooting a distant view or landscape through a window _____	40

4 Additional Information

Correcting the date and time (Lite Touch Zoom 120ED QD only) _____	41
Troubleshooting _____	42
Camera care tips _____	44
Specifications _____	46
For safe handling of the camera _____	48

To take a picture right away

Quick operation guide

If you wish to use this camera immediately, proceed as follows:

For details see the pages indicated for reference.

- 1. Insert a battery.** (☞ p. 12)

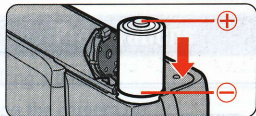

- 2. Turn the camera on.** (☞ p. 13)

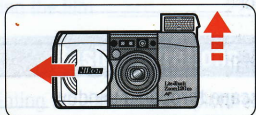

- 3. Load film.** (☞ pp. 14, 15)

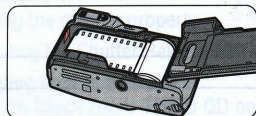

- 4. Select Regular or Panorama mode (Lite Touch Zoom 120ED only).** (☞ p. 20)

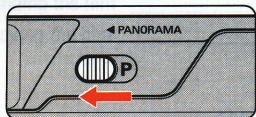

- 5. Press the Zoom button and compose your picture.** (☞ p. 21)

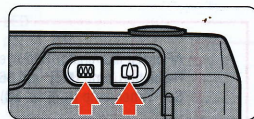

- 6. Lightly press the Shutter Release button.**
(☞ p. 19)



- 7. Check the green LED, then shoot.**
(☞ p. 23)



When the end of the film roll is reached,

The film is automatically rewound.

Remove the film. (☞ p. 25)

Take some trial shots

Before taking important pictures, it is strongly recommended to take a few trial shots first to familiarize yourself with the camera and all of its features.

Nikon cannot be held responsible for malfunctions caused by using the Lite Touch Zoom 120ED / Lite Touch Zoom 120ED QD in ways not specified in this manual.

Camera parts

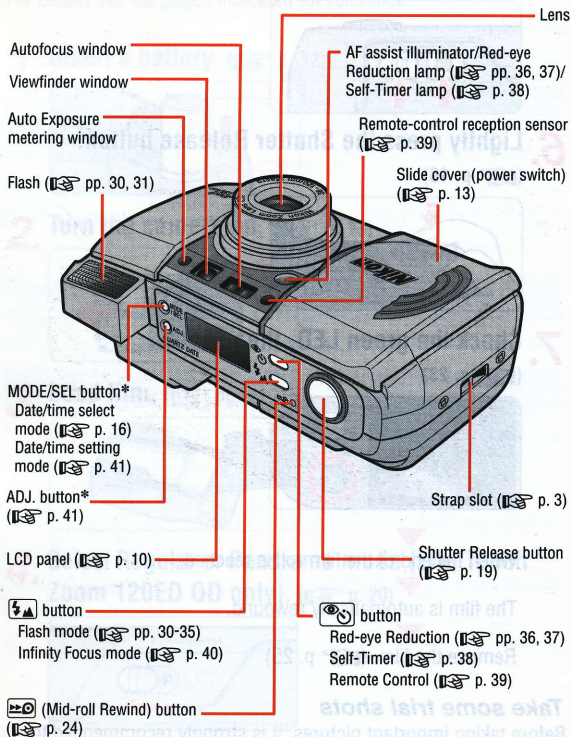

* Lite Touch Zoom 120ED QD only

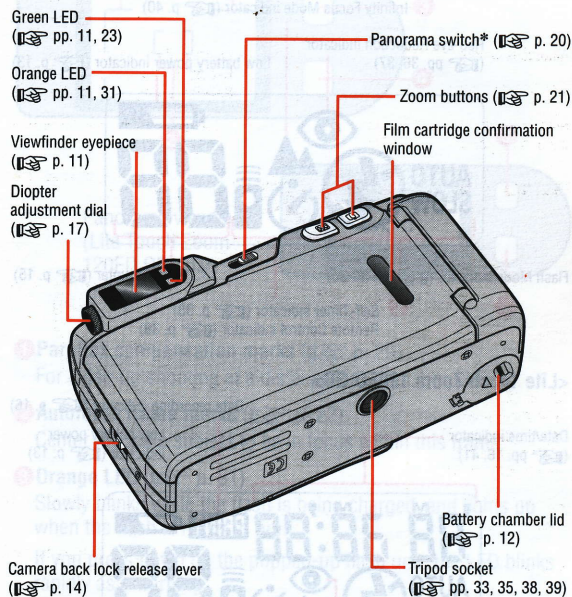

LCD panel

<Lite Touch Zoom 120ED>

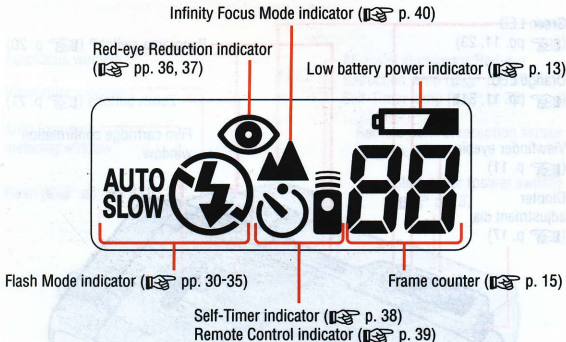

<Lite Touch Zoom 120ED QD>

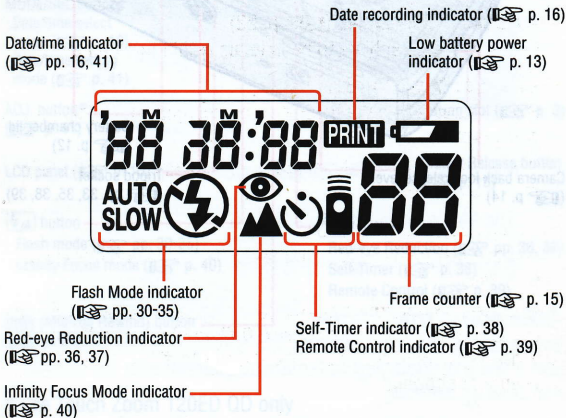

The illustrations are fully labeled for your reference.

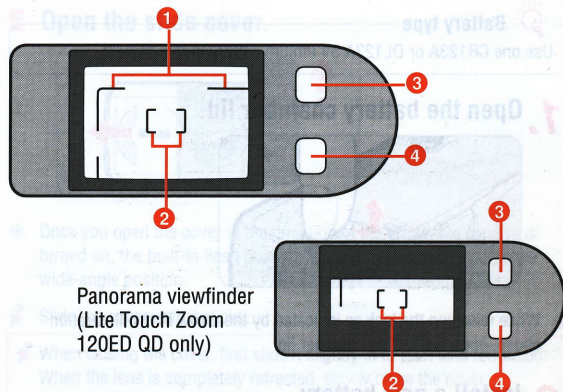

- 1 **Parallax compensation marks** (☞ p. 29)
For close-up shooting at a distance less than 1 m (3.3 ft.).
- 2 **Autofocus frame marks** (☞ p. 22)
Center the main subject to be in focus within this frame.
- 3 **Orange LED** (☞ p. 31)
Slowly blinks while the flash is being charged, and lights up when the flash is ready to fire.
If you press down on the popped-up flash unit, the LED blinks rapidly as a warning.
- 4 **Green LED** (☞ p. 23)
Lights when focus is achieved. It blinks if correct focus cannot be achieved.
In close-up photography, the LED slowly blinks as a warning if the subject is closer than approx. 0.75 m (2.5 ft.) in 38mm wide-angle shooting, or approx. 0.8 m (2.6 ft.) in 120mm telephoto shooting.

Installing a battery



Battery type

Use one CR123A or DL123A 3V lithium battery in this camera.

1. Open the battery chamber lid.

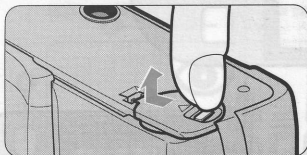

- While releasing the lock as indicated by the arrow in the illustration above, open the battery chamber lid.

2. Install a new battery.



- Observe the correct polarities and insert the battery in the direction shown in the illustration above.

3. Close the battery chamber lid.

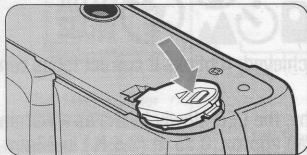

- Firmly press the battery chamber lid until it clicks shut.
- The built-in clock is reset when the battery is removed. Remember to set the time and date. (☞ p. 41)

Turning the camera on

www.butkus.us

■ Open the slide cover.

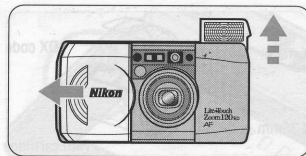

- Once you open the cover in the direction of the arrow, the camera is turned on, the built-in flash pops up, and the lens extends out to the wide-angle position.

- Slide the cover until it clicks.

- When closing the cover, first slide it slightly in to start lens retraction. When the lens is completely retracted, slowly close the cover.

Checking the battery power

■ Check the Low Battery Power indicator (🔋) on the LCD panel.

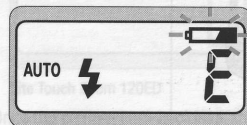

Lite Touch Zoom 120ED

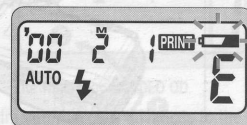

Lite Touch Zoom 120ED QD

- If "🔋" is not indicated, battery power is sufficient.
- If "🔋" is blinking, or all the indicators on the LCD panel do not appear, the battery is exhausted. Replace it with a new one.
- Always check the battery condition before shooting.
- It is recommended to carry spare batteries with you. The batteries may be difficult to obtain in some areas.

Loading the film

Tips on 35mm film

Number of frames

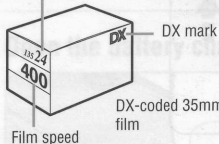

Film speed

DX-coded 35mm film

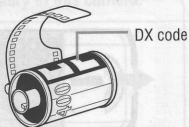

Film cartridge

- Use DX-coded 35mm film with this camera.
- For DX-coded film, film speed is automatically set.
- Film speeds valid for automatic setting are ISO50, 100, 200, 400, 800, 1600, and 3200.
- With a non-DX-coded film, the film speed is automatically set to ISO100.

- When loading/unloading film, be sure not to open the camera back cover into direct sunlight.



Film recommended

It is recommended to use ISO400 film, which provides good results in flash photography, and reasonable protection against camera shake.

1. Open the camera back.

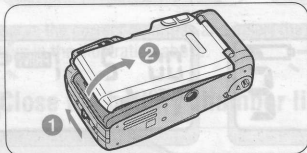

- Slide the camera back lock release lever in the direction of the arrow (1) to open the camera back (2).

2. Insert a film cartridge.

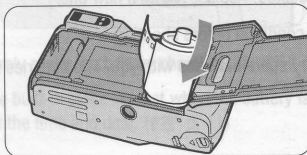

3. Pull the film leader out to the red index mark.

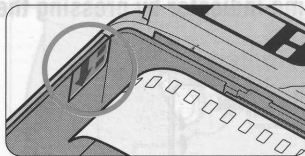

- Hold the film cartridge and ensure film is properly positioned with no slack.

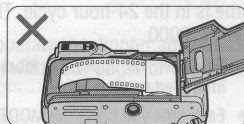
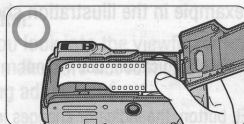

4. Close the camera back, and check that the film has been correctly loaded.

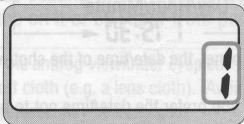

Lite Touch Zoom 120ED

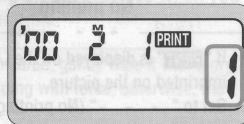

Lite Touch Zoom 120ED QD

- Once the camera back is closed, the film automatically advances to the first frame. Until film loading is complete, "—" blinks on the LCD panel.
- When the film has been properly set, "1" is displayed on the LCD panel.
- If the letter "E" blinks on the LCD panel, film is not properly installed. Open the camera back again and reload film.

Imprinting the date/time on pictures

(Lite Touch Zoom 120ED QD only)

- Select the date/time indicator by pressing the **MODE/SEL** button.

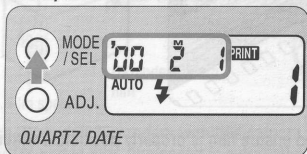

The year is indicated by the lower two digits and printed, and the time is in the 24-hour cycle. The example in the illustration shows Feb. 1, 2000.

- The letter "M" appears to label the month indication, but it is not imprinted on pictures.
- Each time you press the **MODE/SEL** button, the indicator changes in the order shown below:



- If "PRINT" is displayed on the LCD panel, the date/time of the shot will be imprinted on the picture.
- Set to " - - - - " (No printing) if you prefer the date/time not to be imprinted.

Imprint position of date/time



Imprint position in Panorama shooting
Imprint position in Regular shooting

- The imprint positions on film are shown in the illustration.
- ⚠ The imprinted date/time may be difficult to recognize if the imprint position or the subject is:
 - White or bright.
 - Orange or yellow.

www.butkus.us Adjusting diopter

- Turn the diopter adjustment dial.

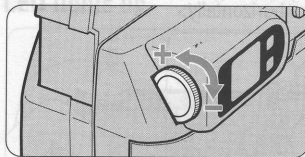

- If the image in the viewfinder is unclear, turn and adjust the diopter adjustment lever.

Caution:

As you look into the viewfinder and operate the diopter adjustment dial, make sure not to injure your eye with your finger or fingernail during adjustment.

About the Antifog Viewfinder

The viewfinder of this camera employs an eyepiece with a special surface coating which reduces fogging on the eyepiece when you breathe on it or by vapor from perspiration.

- ⚠ If the antifog viewfinder eyepiece is smeared, gently wipe it with a dry, soft cloth (e.g. a lens cloth). Avoid wiping with force; otherwise, the eyepiece may be damaged.

Holding the camera properly

■ Hold the camera firmly.

<When holding the camera horizontally>



- Prop your elbows against your body and hold the camera with both hands.

<When holding the camera vertically>





- When holding the camera vertically, make sure that the flash is on top as shown.

- 👉 Do not block the lens, autofocus window, or flash with your fingers or hair, or the strap.
- 👉 Be careful not to press down on the flash unit when it is in the popped up position.

Operating the Shutter Release button

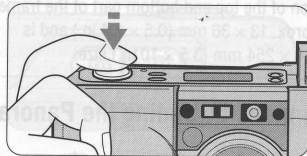
1. Lightly press the button and confirm the green LED lights up.



- When you press the button lightly, the focus and exposure are achieved, and the green LED lights up.
- The focus is locked (Focus lock  p. 26) while the Shutter Release button is depressed lightly.

2. Fully depress the Shutter Release button to take the picture.



- 👉 Pressing the Shutter Release button abruptly in one stroke may result in camera shake. Be sure to slowly press the Shutter Release button.

Selecting Panorama mode

(Lite Touch Zoom 120ED QD only)



What's Panorama mode?

In panorama mode, a portion of the top and bottom part of the frame is cut exposing an area of approx. 13 × 36 mm (0.5 × 1.4 in.) and is usually printed in approx. 89 × 254 mm (3.5 × 10 in.) size.

■ Select Panorama mode by sliding the Panorama switch.

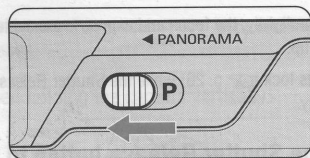

When you slide the Panorama switch to the left, the letter “P” appears, and Panorama mode is selected. When the switch is at the right, Regular mode is selected.

The print results differ as shown below, depending on the setting.

Regular mode



Panorama mode







- The date/time can also be printed in Panorama mode. (☞ p. 16)
- ☞ When compared with regular-format pictures, extra time and cost may be required for developing/printing panorama pictures.

Caution:

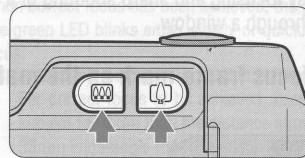
To prevent possible injury to your eye, hold the camera away from your face when you operate the Panorama switch.

■ Press the Zoom button to compose the picture.



- Press the  zoom button for telephoto (120 mm) photography or the  zoom button for wide-angle (38 mm) photography.
- Remove your finger from the button when the desired image size is obtained.
- ☞ When the camera is not operated for more than 2 minutes, the lens automatically retracts to the  (wide-angle) position.

Example of a telephoto photograph



Example of a wide-angle photograph



Shooting

This camera employs a highly accurate passive-type autofocus system, which enables easy focusing and sharp shooting of a distant view or a subject through a window.

1. Center the autofocus frame mark on the main subject.



If the main subject is outside the autofocus frame:

If the main subject is outside the autofocus frame, use the focus lock to achieve focus. (p. 26)

2. Lightly press the Shutter Release button.

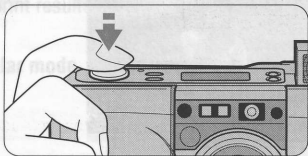

Lighting/blinking of the green LED

When correct focus has been achieved, the green LED lights up. The green LED blinks either slowly or quickly when the subject is out of focus.

● Slow blinking indicates the subject is too close.

For correct focus to be achieved, keep the camera away from the subject for more than the distance shown below:

38mm wide-angle mode: approx. 0.75 m (2.5 ft)

120mm telephoto mode: approx. 0.8 m (2.6 ft).

● Quick blinking indicates that the subject is difficult to focus. Use the focus lock. (p. 26)

3. Slowly press the Shutter Release button all the way.



- If the subject is dark or backlit in Auto Flash mode, the flash fires automatically.
- Pressing the Shutter Release button abruptly in one stroke may result in camera shake.



When not in use, close the slide cover to save battery power.

Rewinding the film

Film rewinds automatically.

- At the end of the film roll, the film rewinding starts automatically.
- While the film is rewinding, the number on the frame counter decreases one by one. When rewinding is complete, the letter “E” blinks for approx. 20 seconds, then stops blinking and remains lit.
- If rewinding stops midway through the roll because of a dead battery, it resumes automatically as soon as the battery is replaced.
- Do not open the camera back until the letter “E” starts blinking.

To rewind the film at mid-roll

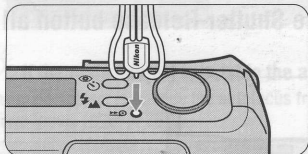

Press the  (mid-roll rewind) button using the stud on the strap lug or the point of ball-point pen.

- Once rewinding starts, there is no need to keep the button pressed.

Removing the film

1. Make sure rewind is complete by checking the letter “E” indication.

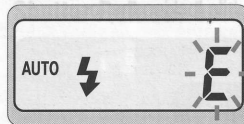

Lite Touch Zoom 120ED

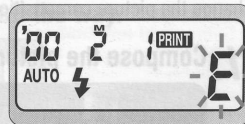

Lite Touch Zoom 120ED QD

2. Open the camera back and remove the film.

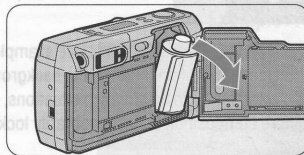

When the main subject is not in the center of the picture

Focus lock photography

When the subject to be focused is outside the autofocus frame in the center of the picture, use focus lock, which enables you to change the picture composition while locking the focus.

1. Compose the picture.



- If the shutter is released in a condition like that in the above example where the main subject is outside the autofocus frame, the background is in focus, and the main subject is out of focus. In such situations, use focus lock to change the picture composition while temporarily locking the focus on the main subject.

2. Focus on the main subject.



- Center the autofocus frame on the main subject and lightly press the Shutter Release button.
- The green LED lights up when correct focus has been achieved, and the focus is locked as long as the Shutter Release button is depressed lightly.



Do not change the camera-to-subject distance

While the green LED lights up, the focus is locked. Do not change the camera-to-subject distance.

Close-up photographing

3. While depressing the Shutter Release button lightly, recompose the picture and depress the Shutter Release button all the way.



Example



Regular

- The area marked with a green LED is the focus lock area.
- The area marked with a green LED is the focus lock area.

2. Check that the green LED lights up.



- If the subject is closer than approximately 2.0 m (6.6 ft.) in wide-angle setting or 0.5 m (1.6 ft.) in Telephoto setting, the green LED will not light up as a warning. Move away from the subject and the green LED lights up.

Difficult-to-focus subjects

The following subjects may be difficult to focus. Use the focus lock (👉 p. 26) to focus on another subject equidistant from the camera, then compose the picture to shoot.

- **Subjects of low contrast, such as blue sky, or shiny subjects, such as a shiny car body or water surface.**

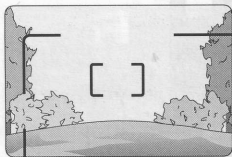

- **Subjects with continuous and repeated patterns.**

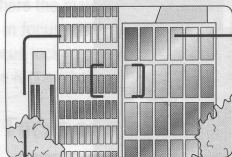

- **Scenes with subjects at different distances within the autofocus frame.**



- **Strongly back lit subjects or those having a bright shiny background.**

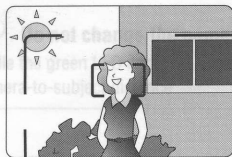

www.butkus.us Close-up photography



Minimum camera-to-subject distance is approx. 0.75 m (2.5 ft.), or approx. 0.8 m (2.6 ft.) in Telephoto shooting

If you wish to shoot a subject such as a flower as large as possible in a picture, you can get as close to the subject as approx. 0.75 m (2.5 ft.) in Wide-angle setting, or approx. 0.8 m (2.6 ft.) in Telephoto setting.

- By setting the Zoom button to the (📷) (telephoto) position, a larger image can be obtained.

1. Compose the picture within the parallax compensation marks.



Regular

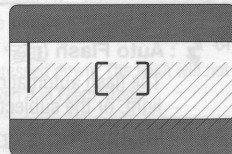

Panorama

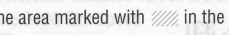
- 👉 The area marked with  in the illustration is included in the picture.
- 👉 Use the parallax compensation marks when the camera-to-subject distance is less than 1 m (3.3 ft.).

2. Check that the green LED lights up, then shoot.

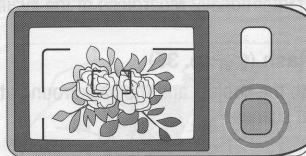

- 👉 If the subject is closer than approx. 0.75 m (2.5 ft.) in Wide-angle setting or 0.8 m (2.6 ft.) in Telephoto setting, the green LED slowly blinks as a warning. Move away from the subject until the green LED lights up.

Flash photography

Selecting the flash mode

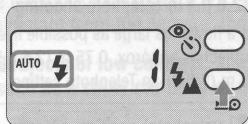

Lite Touch Zoom 120ED

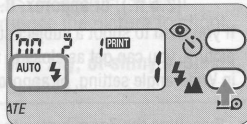

Lite Touch Zoom 120ED QD

● You can select any of five flash modes by pressing the button.



AUTO : **Auto Flash** (p. 32)

The flash automatically fires when there is not enough light, or the subject is backlit.

: **Infinity Focus** (p. 40)

For shooting a distant scene or landscape more sharply.

: **Flash Cancel** (p. 33)

To cancel flash operation in lighting conditions where normally the flash would automatically fire.

: **Anytime Flash** (p. 34)

To fire the flash intentionally regardless of the available light.

AUTO SLOW : **Slow-Sync Flash** (p. 35)

To brighten both the subject and the background at dusk or in night scenes.

Lighting/blinking of the orange LED

The orange LED blinks slowly while the flash is being charged, and lights up when the flash is ready to fire. It blinks quickly when you press down on the flash unit.

● The orange LED lights up:

... Flash charging is completed. The flash is ready to fire.

● The orange LED blinks **slowly**:

... The flash is being charged. The shutter cannot be released until the LED lights up. Once take your finger away from the Shutter Release button, and lightly press the button again. If the orange LED lights up, release the shutter.

● The orange LED blinks **quickly**:

... The popped-up flash unit is being pressed down. The flash will not fire when you release the shutter, even if in Flash mode.

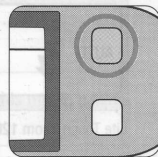

Flash shooting range

The reference distance values are shown below.

With ISO100 film speed

(wide-angle) setting: approx. 0.75 to 4.1 m (2.5 to 13.4 ft.)

(telephoto) setting: approx. 0.8 to 2 m (2.6 to 6.6 ft.)

With ISO400 film speed

(wide-angle) setting: approx. 0.75 to 8.2 m (2.5 to 26.9 ft.)

(telephoto) setting: approx. 0.8 to 4 m (2.6 to 13.1 ft.)

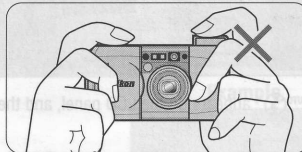

The shutter may be released even while the flash unit is pressed down, but the flash will not fire. Do NOT touch the flash unit.

To automatically fire the flash

Auto Flash mode

The flash automatically fires when there is not enough light or the subject is backlit.

1. Open the slide cover.

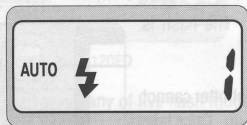

Lite Touch Zoom 120ED

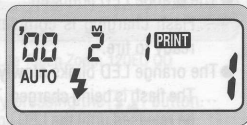

Lite Touch Zoom 120ED QD

- When you open the slide cover, the power is turned on and the built-in flash pops up. The "AUTO" lightning bolt mark appears on the LCD panel and Auto Flash mode is automatically selected.

Automatic flash firing for a backlit scene

When the subject is backlit, the flash is automatically fired while simultaneously compensating exposure for the main subject and the background.

2. Check that the orange and green LEDs light up, then shoot.



Example



- If there is enough light, "AUTO" with a lightning bolt icon appears on the LCD panel, and the flash does not fire.
- Pressing down on the popped-up flash unit will prevent the flash from firing. Do NOT touch the flash unit.

To cancel flash operation

Flash Cancel mode

Use this mode in places, such as museums, where flash photography is prohibited, or to achieve a natural lighting effect at dusk or for night scenes.

1. Use a tripod or place the camera on a stable flat surface.



Use a tripod for Flash Cancel mode

Since slow shutter speeds are usually selected in this mode, use a tripod to prevent camera shake.

2. Press the lightning bolt with a mountain icon button until "Flash Cancel" appears on the LCD panel.

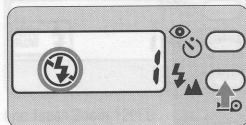

Lite Touch Zoom 120ED

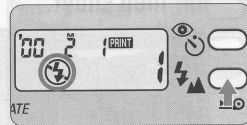

Lite Touch Zoom 120ED QD

3. Check that the green LED lights up, then shoot.



Example



To fire the flash intentionally

Anytime Flash mode

Use this mode to intentionally fire the flash without regard to light conditions.

1. Press the  button until “” appears on the LCD panel.

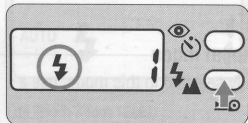

Lite Touch Zoom 120ED

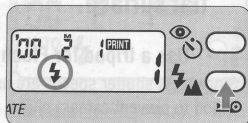

Lite Touch Zoom 120ED QD

2. Check that the orange and green LEDs lights up, then shoot.



- While the orange LED is blinking with the Shutter Release button pressed lightly, the flash is being charged, and the shutter cannot be released. Lightly press the Shutter Release button again, and release the shutter after the orange LED stops blinking and stays lit.
- Pressing down on the popped-up flash unit will prevent the flash from firing. Do NOT touch the flash unit.

Example



To photograph a person in a night view

Slow Sync Flash mode

Use this mode to brighten both the subject and the background in a night view or at dusk.

1. Use a tripod or place the camera on a stable flat surface.



Use a tripod for Slow Sync Flash mode

Since slow shutter speeds are usually selected in this mode, use a tripod to prevent camera shake.

2. Press the  button until “**AUTO SLOW** ” appears on the LCD panel.



Lite Touch Zoom 120ED

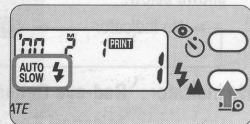

Lite Touch Zoom 120ED QD

- If there is enough light, **AUTO SLOW**  appears on the LCD panel, and the flash does not fire.

3. Check that the orange and green LEDs light up, then shoot.



Example



- While the orange LED is blinking with the Shutter Release button pressed lightly, the flash is being charged, and the shutter cannot be released. Lightly press the Shutter Release button again, and release the shutter after the orange LED stops blinking and stays lit.
- Pressing down on the popped-up flash unit will prevent the flash from firing. Do NOT touch the flash unit.

To reduce the "Red-eye" effect

Red-eye Reduction mode

In flash photography, the subject's eyes may sometimes appear bright red. To reduce this "red-eye" effect, use this mode.

1. Press the  button until "👁" appears on the LCD panel.



Lite Touch Zoom 120 ED

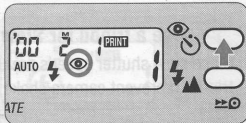

Lite Touch Zoom 120 ED QD

- Each time you press the  button, the indicator changes in the order shown below:



No indicator: **Red-eye Reduction mode canceled**

To cancel Red-eye Reduction mode.

 : **Red-eye Reduction mode**

To reduce the "Red-eye" effect.

 : **Self-Timer/Remote Control mode**

(pp. 38, 39)

For self-timer or remote control operation.

Note that Red-eye Reduction is automatically set when the self-timer is used.

2. Compose the picture, then lightly press the Shutter Release button.

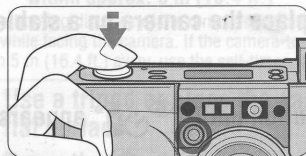

3. Check that the orange and green LEDs light up, then shoot.



Both camera and subject be still

The Red-eye Reduction lamp lights up for approx. a second before the flash fires. Be careful not to move the camera or let the subject move until the flash fires.

- While the orange LED is blinking with the Shutter Release button pressed lightly, the flash is being charged, and the shutter cannot be released. Lightly press the Shutter Release button again, and release the shutter after the orange LED stops blinking and stays lit.
- Red-eye Reduction mode is not automatically canceled by turning the power off. To cancel the Red-eye Reduction mode, press the  button until "👁" disappears from the LCD panel.







About Red-eye Reduction mode

This mode is not recommended when shooting fast-moving subjects.

Using the self-timer

Use the self-timer when you wish to include yourself in the picture.

1. Use a tripod or place the camera on a stable flat surface.
2. Press the  button until “  ” appears on the LCD panel.



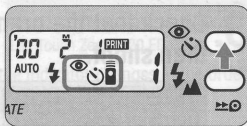

Lite Touch Zoom 120ED

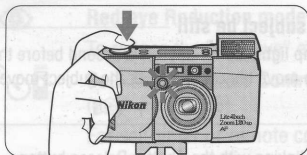

Lite Touch Zoom 120ED QD

3. Compose the picture, and press the Shutter Release button.



- Focus and exposure are achieved by pressing the Shutter Release button lightly.
 - When the Shutter Release button is pressed all the way, the Red-eye reduction/Self-timer lamp blinks for approx. 8 seconds, then lights up for 2 seconds before the shutter is released.
 - After the shot, Self-Timer mode is canceled.
-  Self-Timer mode is automatically canceled if the camera is not operated for more than approx. 2 minutes or when the slide cover is closed.





Using the remote control (optional)

For releasing the shutter from a distance



The shooting distance for remote control operation is within approx. 5 m (16.4 ft.)

The shooting distance of the remote control is within approx. 5 m (16.4 ft.) while facing the camera. If the camera-to-subject distance is more than 5 m (16.4 ft.) away, use the self-timer. (p. 38)



1. Use a tripod or place the camera on a stable flat surface.
2. Press the  button until “  ” appears on the LCD panel.

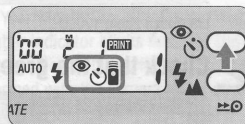

Lite Touch Zoom 120ED



Lite Touch Zoom 120ED QD

-  Remote Control mode will be automatically canceled if the camera is not operated for more than approx. 2 minutes or when the slide cover is closed.
-  If the reception sensor on the camera is exposed to strong light, the remote control may not operate properly.

3. Compose the picture, aim the remote control unit at the camera, and press the Shutter Release button on the unit.





- The Red-eye reduction/Self-timer lamp lights up for approx. 2 seconds before the shutter is released.
 - Within 2 minutes after taking the last shot, you can still continue to shoot by remote control.
-  The life of the battery in the remote control unit is approx. 10 years. If the battery is exhausted, the shutter may not be released with the remote control. Visit an authorized Nikon dealer or service center to change it. (at your expense)

Shooting a distant view or landscape through a window

Infinity Focus mode

This mode is good for shooting a distant view more sharply, or a landscape through a window.

1. Press the  button until “ ” appears on the LCD panel.



Lite Touch Zoom 120ED

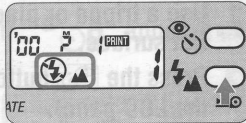

Lite Touch Zoom 120ED QD

2. Check that the green LED lights up, then shoot.



-  Flash is automatically canceled in this mode.

Correcting the date and time

(Lite Touch Zoom 120ED QD only)

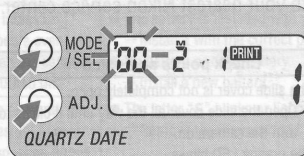

1. Press the **MODE/SEL** button for more than 2 seconds.

- When the date/time display format is Year/Month/Day, Month/Day/Year, or Day/Month/Year, the left most number indicator blinks first. For Day/ Hour/Minute display, the center number indicator blinks first.
- The date/time correction can be performed with the camera either on or off. When the camera is on, the data will be immediately registered if the slide cover is closed, or the Mid-roll Rewind button or a Zoom button is pressed while the setting is in progress.

2. Press the **ADJ.** button to set the blinking digit.

- Each time you press the **ADJ.** button, the number advances by one.
- Holding the **ADJ.** button pressed for more than 2 seconds advances the number quickly.

3. When the blinking indicator is correctly set, press the **MODE/SEL** button again so that the next indicator blinks.

- Repeat steps 2 and 3 to set all the digits.



When the battery is replaced

- The LCD panel shows “00 00.”
- The date/time is not imprinted in pictures taken while “00 00” is indicated. Set the date and time following the above procedure.

Troubleshooting

Track down the cause of trouble using the following chart. It may save you a trip to your nearest Nikon service center.

Problem		Check points and solution	Ref. page		
Shutter	The shutter cannot be released.	<ul style="list-style-type: none"> ● The slide cover is not completely open. <ul style="list-style-type: none"> → Open the slide cover all the way until it clicks to turn the camera on. ● The orange LED blinks. <ul style="list-style-type: none"> → The flash is being charged. Once take your finger away from the Shutter Release button, lightly press the button again, and release the shutter after the orange LED stops blinking and stays lit. ● Letter "E" lights up on the LCD panel. <ul style="list-style-type: none"> → A rewound roll of film is inside. Replace it with a new roll. ● No indicator on the LCD panel. <ul style="list-style-type: none"> ▸ The battery is exhausted. Replace it with a new one. 	13 11,31 14,15, 24,25 12		
		Flash	The flash does not fire.	<ul style="list-style-type: none"> ● The orange LED blinks. <ul style="list-style-type: none"> ▸ The flash is being charged. Once take your finger away from the Shutter Release button, lightly press the button again, and release the shutter after the orange LED stops blinking and stays lit. ● "⊕" lights up on the LCD panel. <ul style="list-style-type: none"> → The flash does not fire when the subject is bright enough. To fire the flash, set the camera to Anytime Flash mode. ● No indicator or the "⊖" blinks on the LCD panel. <ul style="list-style-type: none"> ▸ Battery power is low or the battery is exhausted. Replace the battery with a new one. ● The orange LED blinks quickly. <ul style="list-style-type: none"> ▸ Check that the flash unit is not pressed down. Do not touch the flash unit. 	11,31 32,34, 35 12 11,31
				Focus	The subject appears out of focus in the print.

Problem		Check points and solution	Ref. page
LCD panel	No indicator appears even when the camera is turned on.	<ul style="list-style-type: none"> ● The battery is installed with wrong polarities. <ul style="list-style-type: none"> → Install it with the correct polarities. ● No battery or dead battery. <ul style="list-style-type: none"> → Install a new battery. 	12 12,13
	The numeral "f" does not appear even when film is loaded.	<ul style="list-style-type: none"> ● The letter "E" blinks or lights up. <ul style="list-style-type: none"> → Remove the film and load it again. 	14,15
Remote control (Optional)	The shutter cannot be released using the remote control.	<ul style="list-style-type: none"> ● You are out of the remote control working range. <ul style="list-style-type: none"> → Operate the remote control in a range within 5 m (16 ft.) facing the camera. ● Two or more minutes have elapsed since you set the camera to Remote Control mode. <ul style="list-style-type: none"> → Set the camera to Remote Control mode again. ● The remote control is operated in backlit. <ul style="list-style-type: none"> → Change the position of the remote control. ● The service life of the battery in the remote control has lapsed (10 years). <ul style="list-style-type: none"> → Visit an authorized Nikon dealer or service center to change it (at your expense) 	39 39 39 —

A characteristic of electronic cameras

In rare cases, when strong static electricity or the like is applied to the camera, the camera may not work properly. If this happens, remove the battery and reinstall it. When the battery is removed, the date/time are reset. Set them after reinstall the battery. (p. 41)

Camera care tips

When the camera is not in use:

Close the slide cover to turn the camera off when not in use.

This prevents accidental release of the shutter and resulting battery drain.

When the camera will not be used for a long period:

Remove the battery and store the camera in a cool, dry, clean place.

It is recommended to install a battery once a month and fire the flash several times to prevent deterioration of the capacitors.

Keep the camera dry:

The Lite Touch Zoom 120ED / Lite Touch Zoom 120ED QD is not waterproof, and therefore should not be exposed to rain or saltwater.

Do not apply strong shock to the camera:

Do not drop the camera or hit it against a hard surface.

When storing the camera:

Do not leave the camera in an excessively hot and humid place, such as inside a closed car or car trunk or in front of a heater, or a place exposed to chemicals such as camphor or naphthalene.

Using a desiccant during storage is recommended.

Maintenance:

Use a dry, soft cloth or commercially available blower brush or lens cleaner to remove dirt and smudges.

Lightly wipe away the dirt on the Antifog Viewfinder eyepiece with a dry soft cloth (e.g. a lens cloth).

Use the flash intermittently:

Firing the flash repeatedly makes the battery and camera hot. Allow sufficient time for them to cool off before taking pictures again.

When using the camera at low temperature:

The camera may not operate at low temperature with a nearly exhausted battery. Use a fresh battery at low temperatures, keep spare batteries warm, and use them alternately.

Battery power may be restored when the temperature returns to normal.

Specifications

Type of camera

35mm autofocus lens-shutter camera with Nikon zoom lens

Usable film

DX-coded 35mm film in film cartridge

Picture format

Normal: 24 × 36 mm

Panorama (Lite Touch Zoom 120ED QD only): 13.3 × 36 mm

Lens

38 mm f/5.3–120 mm f/10.5, 7 elements in 5 groups (ED lens and aspheric lenses are used)

Shutter

Programmed electronic type; also serves as diaphragm blades

Viewfinder

Real-image viewfinder; frame coverage: approx. over 80% in regular-size frame; approx. 0.44× magnification at 38mm, approx. 1.13× at 120mm; Diopter adjustment: -2 to +2 DP, Antifog viewfinder

Viewfinder information

Image size frame with parallax compensation marks; Panorama-format frame marks (Lite Touch Zoom 120ED QD only); Autofocus frame marks: Green LED (in-focus indicator) – Lights up: subject focused, Blinks slowly (at 2 Hz); subject is too close to achieve correct focus, Blinks quickly (at 8 Hz); subject is difficult to focus; Orange LED (flash ready-light) – Lights up: flash ready, Blinks slowly (at 2 Hz); flash being charged, Blinks quickly (at 8 Hz); the popped-up flash unit is being pressed down (at 8 Hz)

Focusing

Passive autofocus system; Activated by lightly pressing Shutter Release button; Distance range from approx. 0.75 m (2.5 ft.) to infinity at 38 mm, approx. 0.8 m (2.6 ft.) to infinity at 120 mm

Focus lock

Focus is locked as long as the Shutter Release button lightly pressed.

Exposure control

Electronically controlled program AE: auto exposure range (ISO100): EV4–17 at 38mm or EV6–19 at 120mm, (ISO400): EV6–17 at 38mm, EV6-19 at 120mm; Flash fires automatically if the available light is low

Film speed setting

ISO50, 100, 200, 400, 800, 1600, and 3200 film automatically set

Film loading

Film automatically advances to the first frame upon completion of film loading; With a film cartridge confirmation window

Frame counter

Shown in the LCD panel; Additive type; Counts back during film rewind

Self-timer

Electronically controlled; Activated by depressing the Shutter Release button; Self-timer lamp blinks and lights up to show when ready; Timer duration 10 seconds; Cancellable

Film advance

Film automatically advances by one frame after each shot; Auto rewind at the end of film roll; Mid-roll rewind function available

Remote control (optional)

Infrared wireless remote control; 2 sec. delay shutter release; Effective range is within approx. 5 m (16 ft.) straight in front of the camera; Battery will last for approx. 10 years; Dimensions (W × H × D): approx. 60 × 27 × 10 mm (2.4 × 1.1 × 0.4 in.); Weight (including battery): approx. 13 g (0.5 oz.)

Built-in flash

Four flash modes available: Auto Flash, Flash Cancel, Anytime Flash, and Slow Sync Flash; Flash automatically fires when there is not enough light or subject is backlit; Flash shooting range (ISO100): approx. 0.75–4.1 m (2.5–13.4 ft.) at 38mm, approx. 0.8–2 m (2.6–6.6 ft.) at 120mm, (ISO400): approx. 0.75–8.2 m (2.5–26.9 ft.) at 38mm, approx. 0.8–4 m (2.6–13.1 ft.) at 120mm; Shutter release button is locked during flash charging; Recycling time approx. 6 sec.

Red-eye Reduction mode

Red-eye Reduction lamp lights up for approx. 1 sec. before flash fires.

Battery life

Approx. 12 rolls of 24-exposure film when flash is used for half the exposures

LCD panel (Power is on)

Frame counter, Flash mode, Red-eye Reduction, Self-timer/Remote Control, Infinity Focus mode, Low battery power, Date recording (Lite Touch Zoom 120ED QD only), Time/Date (Lite Touch Zoom 120ED QD only)

Power source

One 3V lithium battery (CR123A type or DL123A)

Date imprint function (Lite Touch Zoom 120ED QD only)

Imprint uses 7-dot LED; Functions with panorama-format pictures; Auto film speed setting with DX codes (ISO 50–3200); Printed date include year, month, day, hour, (24-hour cycle with no AM/PM) and minute with five choices; Year/Month/Day, Month/Day/Year, Day/Month/Year, Day/Hour/Minute, and no-imprint; Leap year adjustment until 2039; Power source same as camera body; Built-in clock with timing accuracy within ±90 seconds a month

Dimensions (W × H × D)

Approx. 114 × 60 × 41 mm (4.5 × 2.3 × 1.6 in.)

Weight (without battery)

Approx. 210 g (7.4 oz.)

- Specifications apply when a fresh battery is used at normal temperature (20°C or 68°F).
- Specifications and design are subject to change without notice.